

RATIO OUTDOOR LUMINAIRE FAMILY



RATIO AREA/SITE

Hubbell Outdoor Lighting's Ratio area/site family is available in a variety of outputs allowing you to customize your lighting design to meet application requirements. With a new spin on a classic rectilinear form, Ratio brings the traditional shoebox aesthetic into the next generation of LED lighting. Ratio features a dense optical array which provides reduced pixilation and increased visual comfort without compromising performance. Designed for sustained, long-term performance with advanced thermal management, an elegantly simple heat sink and industry leading surge protection.



VERSATILE MOUNTING



Knuckle

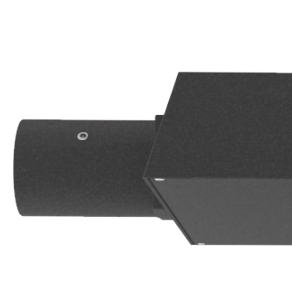

Mast Arm

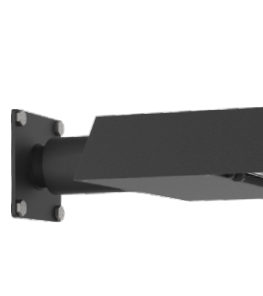

Wall Mount

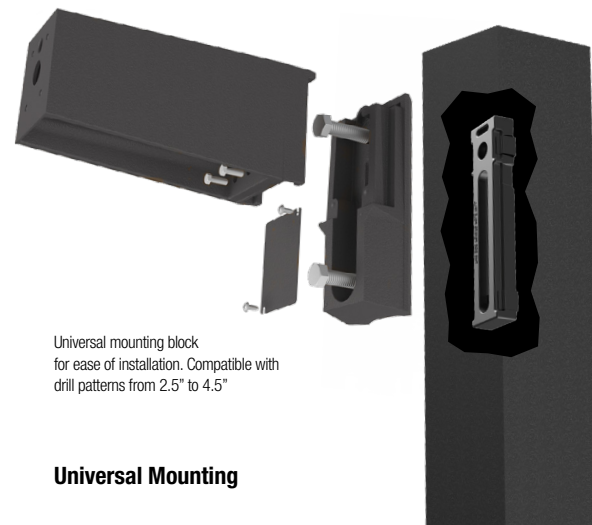

Universal mounting block for ease of installation. Compatible with drill patterns from 2.5" to 4.5"

Universal Mounting

Size	RAR1-80L	RAR1-160L	RAR2-320L	RAR2-480L
Lumens	3,000–6,000	9,000–18,000	15,000–21,000	24,000–48,000
Watts	25/50W	70–135W	110–165W	185–340W
LPW	120	129	136	136
Mounting	Arm & Knuckle	Arm & Knuckle	Arm & Knuckle	Arm & Knuckle
CCT	3K, 4K, 5K	3K, 4K, 5K	3K, 4K, 5K	3K, 4K, 5K
Distributions	II, III, IV, V	II, III, IV, V	II, III, IV, V	II, III, IV, V
IP Rating	IP66	IP66	IP66	IP66
Legacy Equivalence	100–175W	175–400W	250–400W	400–750W

RATIO AREA/SITE

RAR3

The Size 3 Ratio Area fixture combines the sleek aesthetic of the existing Ratio products with an expanded offering of lumen outputs, optics and mounting options. This fixture is not only a great solution for new construction applications, but also retrofit as a single product can replace up to two 1000W metal halide luminaires.

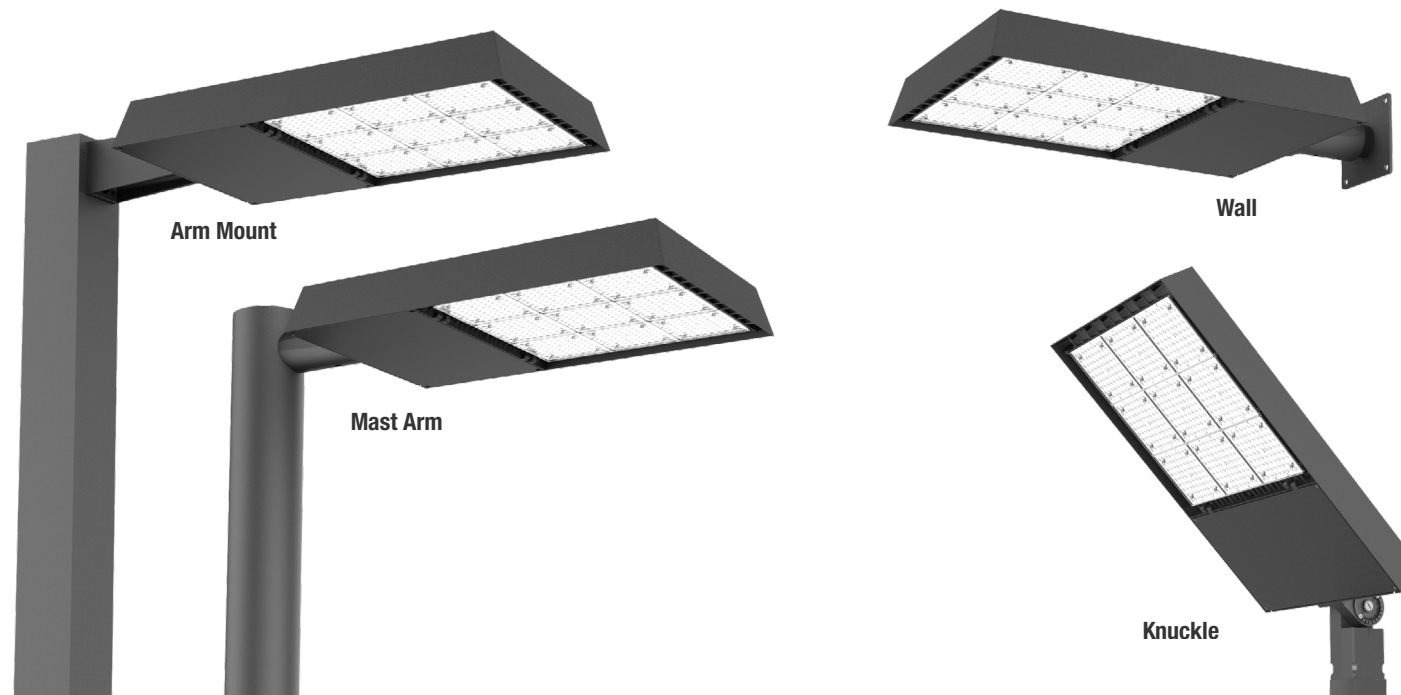

AREA/SITE



Knuckle

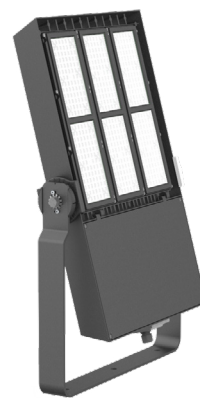

Yoke



Trunnion

FLOOD



Size	RAR3-540L	RAR3-720L
Lumens	35,000–65,000	55,000–80,000
Watts	235-480W	375-575W
LPW	144	150
Mounting	Knuckle, Trunnion, Yoke	Arm, Mast Arm, Knuckle, Wall
CCT	3K, 4K, 5K	3K, 4K, 5K
Distributions	N, M, W	II, III, IV, V
IP Rating	IP66	IP66
Legacy Equivalence	1,000W, 1,500W	1,000W, 1,500W

RATIO AREA/SITE - PERFORMANCE

IES COMPARISON

The Ratio is available with four distinct distribution patterns to illuminate a variety of applications. Featuring Micro Strike Optics which maximizes target zone illumination with minimal losses at the house-side, reducing light trespass issues. This outstanding optic control simplifies layouts and installations, reducing pole count, energy consumption, lowers installation costs and improves visual acuity.

Luminaire	Parking Area									
	Illuminance (Fc)					Output				
	Minimum	Average	Maximum	Avg/Min	Max/Min	Watts	Lumens	Pole Spacing	# Of Poles	Total Watts
RAR-2-480L-210-4K7-4W @ 25' MH	1.4	3.0	6.6	2.1	4.7	210	27,000	130'	4	840
Typical Area/Site Luminaire @ 25' MH	1.0	2.9	8.3	2.9	8.3	215	27,524	100'	6	1,290

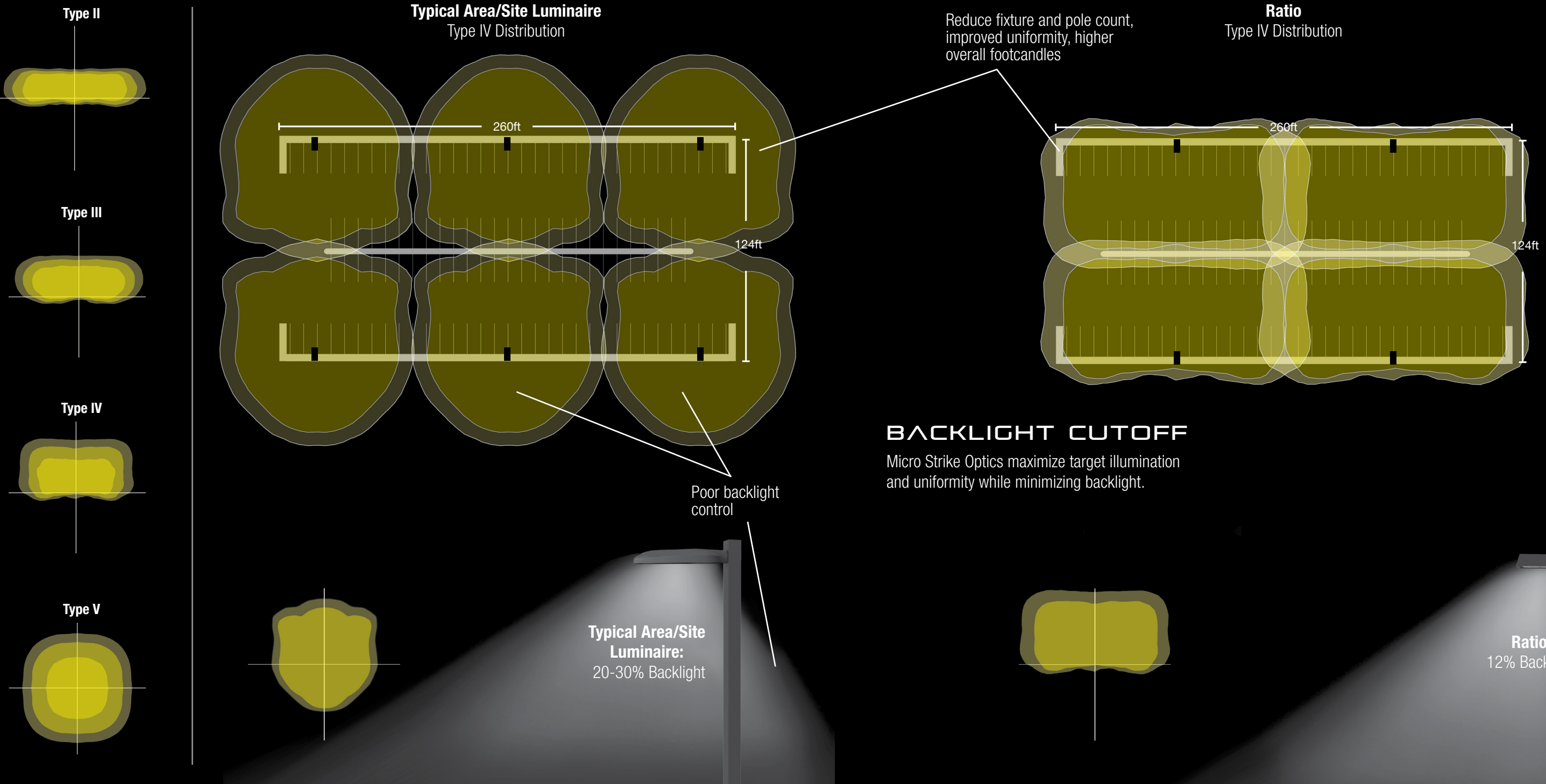

RATIO FLOOD

Hubbell Outdoor Lighting's Ratio flood series is available in four sizes as well as a variety of outputs allowing you to customize your lighting design to meet application requirements.

The Ratio flood series was designed in cohesion with the site/area products to provide a sleek yet timeless product family to be used throughout a site. Ratio features a dense optical array which provides reduced pixelation and increased visual comfort without compromising performance.

Designed for sustained, long-term performance with advanced thermal management and elegantly simple heat sink and industry leading surge protection. Scalable sizes, multiple beam spreads and interchangeable mountings make this an extremely versatile product family.



VERSATILE FAMILY

From the compact RFL2 to the large RFL5, the Ratio family of floods provides lighting solutions for every flood lighting application large or small.



Visor
RFL4 – RFL5

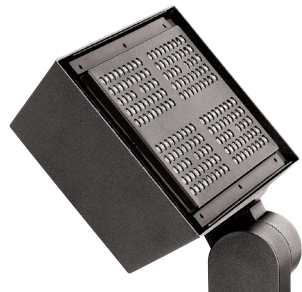

Louver
RFL4 – RFL5



Trunnion Mount
RFL4 – RFL5

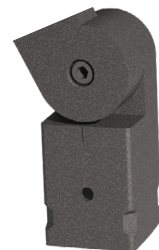

Knuckle Mount
RFL4 – RFL5



Knuckle Mount
RFL2 – RFL3



Trunnion Mount
RFL2 – RFL3



Size	RFL2	RFL3	RFL4	RFL5
Lumens	3,500	5,000/7,000	12,000/15,000	18,000/25,000/30,000
Watts	25W	40/50W	95/120W	130/190/265W
LPW	130	125/140	125/130	125/130/115
Mounting	Knuckle, Trunnion	Knuckle, Trunnion	Knuckle, Trunnion	Knuckle, Trunnion
CCT	3K, 4K, 5K	3K, 4K, 5K	3K, 4K, 5K	3K, 4K, 5K
Distributions	N, M, W	N, M, W	N, M, W	N, M, W
IP Rating	IP66	IP66	IP66	IP66
Legacy Equivalence	100-150W	175-250W	250-400W	750W-1000W

RATIO FLOOD - PERFORMANCE

IES DISTRIBUTIONS

The Ratio flood series is available in three NEMA distribution patterns utilizing Micro Strike Optics for optimal performance.

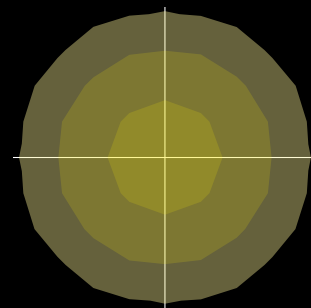

NEMA 6X6

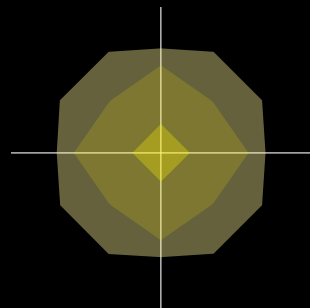

NEMA 4X4

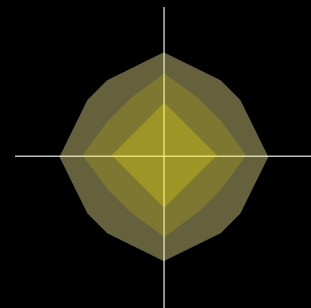

NEMA 2X2

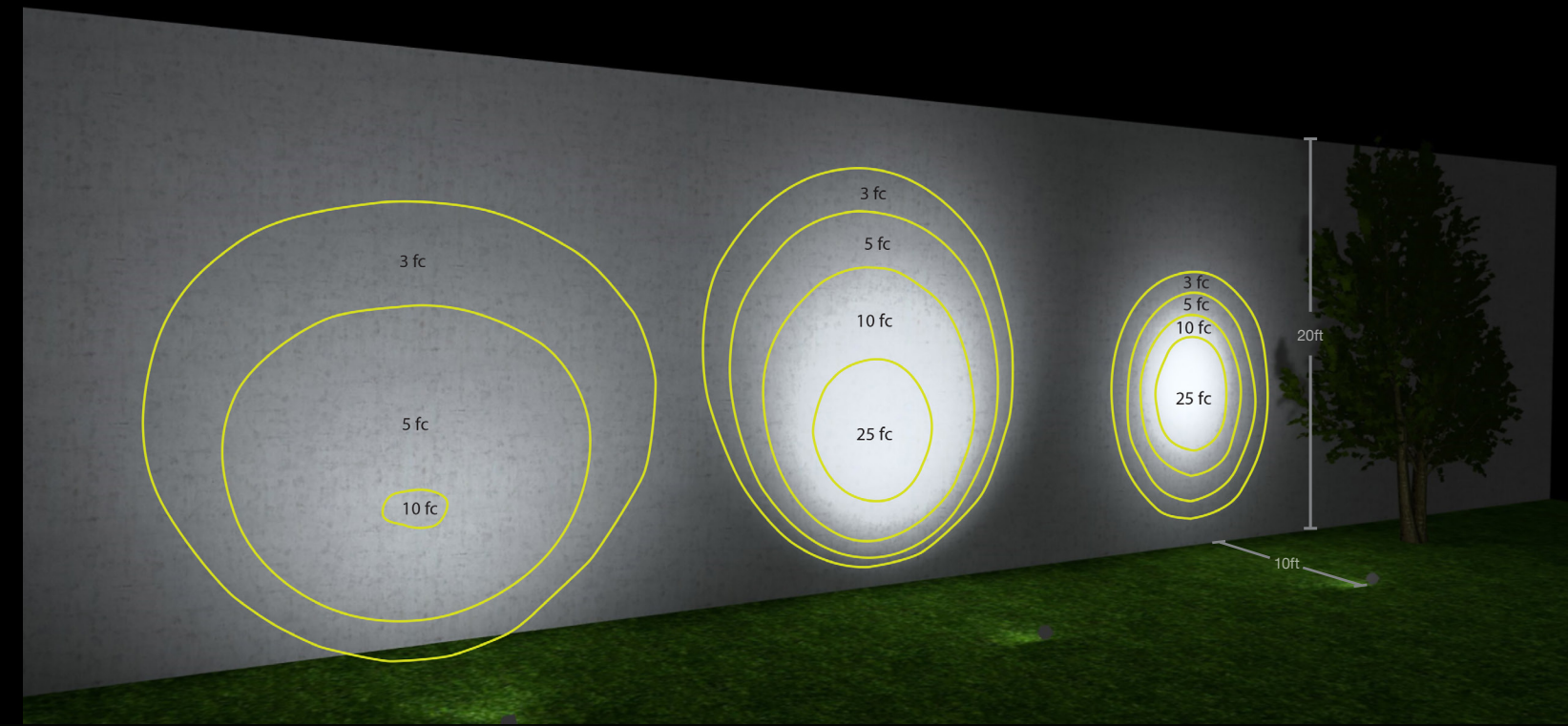

SUPERIOR DESIGN

The Ratio flood series was specifically designed to shed water. The vented housing, in addition to cooling the fixture, also eliminates the ability for water to build up anywhere on the luminaire surface.

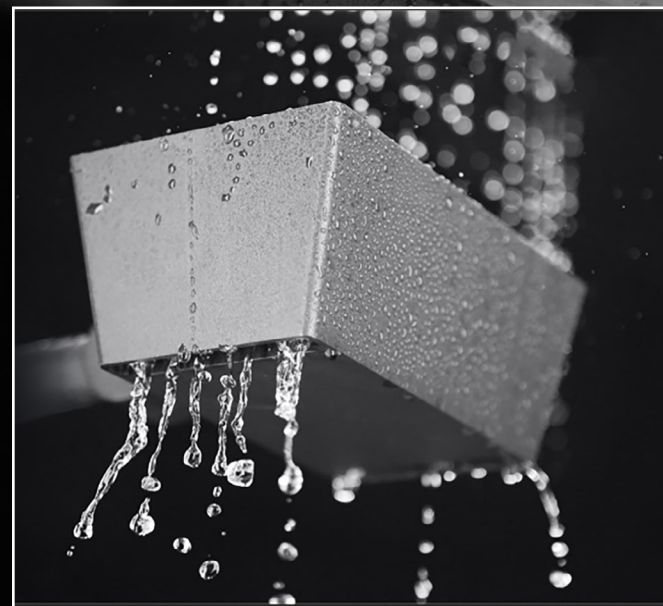

OPTICAL EXCELLENCE

All optical geometry is on the inside of the lens creating a smooth finish that limits debris build up on the external surface. The lens also has no external hardware allowing for even pressure on the gasket preventing water intrusion.

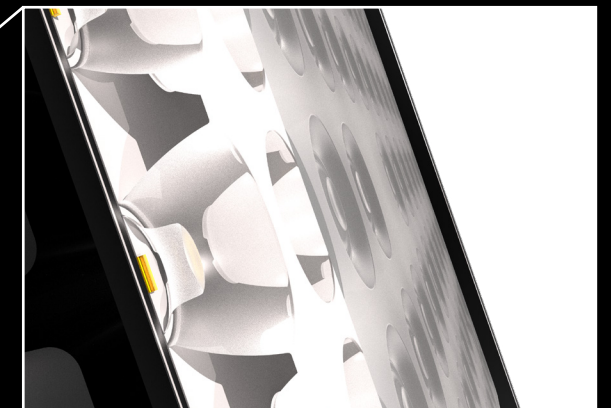
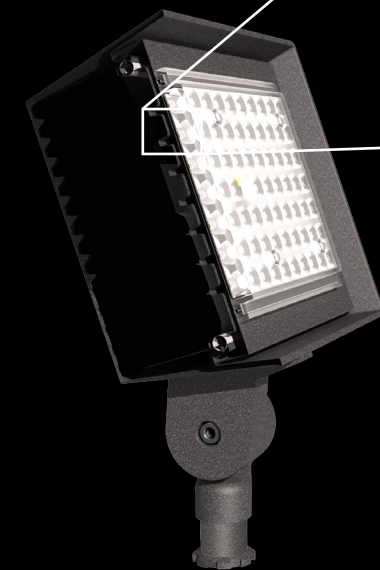

RATIO COMPREHENSIVE SOLUTIONS

Hubbell Outdoor Lighting provides comprehensive and coordinated solutions for a variety of exterior applications. A full line of luminaires are available with complementing shapes and styles that proportionally scale and add balance to the outdoor environment. Quality construction and industry leading performance complete the package. Control options featuring photocontrols, occupancy controls and NX Distributed Intelligence™ enable optimum energy savings and customization.



AREA/SITE



FLOOD



WALL



CANOOPY



RATIO

GEOPAK™

LUMA
SQUARE

RATIO VISUAL COMFORT

Ratio's unique optical design combines visual uniformity with the precise distribution of a TIR optic. Five times the luminous surface area provides optimal light distribution plus visual comfort.

Competitor Optic (COB)



Micro Strike Optics



	Competitor Optic (COB)	Micro Strike Optics
Approximate Luminous Surface Area	10in ²	50in ²
Approximate Total Lumen Output	10,000	10,000
Lumens per inch ²	1,000	200

Lumasquare™

A specially designed acrylic lens provides blended, non-pixelated illumination for unprecedented visual comfort.

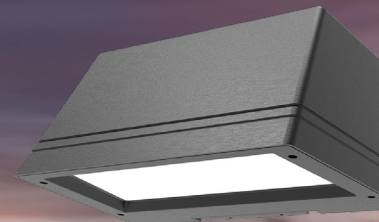

GeoPak™

Designed for optimal visual comfort and maximum performance, the low glare versions provide excellent illumination and uniformity with zero LED pixelation.

RATIO INTEGRATED CONTROLS

Controls in area/site applications save energy, extend luminaire life and allow customizable solutions. Sensors control light output based on area utilization and are used for energy savings and local code compliance.



STANDALONE CONTROLS FUNCTIONALITY

Occupancy Sensor

- Individual fixture control
- Dims product when space is not occupied



Photocontrol

- Individual fixture control
- Turns fixture on when sun sets



INTEGRATED CONTROLS

NX DISTRIBUTED INTELLIGENCE

Hubbell Controls Solutions' NX Distributed Intelligence™ platform delivers a lighting control solution capable of seamlessly connecting exterior and interior applications.

- Standalone or networked fixture control
- Astronomical time schedules
- BACnet building networking
- Connects with indoor wired, wireless or hybrid networks
- Wireless setup via app
- Occupancy Sensor option dims product when space is not occupied



7-Pin Receptacle

- Compatible with 3-pin, 5-pin or 7-pin photocontrols
- Turns fixture on when sun sets, off when sun rises
- Wireless networked solution
- For use with a variety of control platforms

*Additional accessories required.



RATIO AREA/SITE ORDERING INFORMATION

STOCK ORDERING INFORMATION ORDERING EXAMPLE: RAR1-100-4K-4

CATALOG DESCRIPTION	LUMENS	WATTAGE	LED COUNT	CCT/CRI	VOLTAGE	DISTRIBUTION	MOUNTING	FINISH
RAR1-100-4K-3	12,000	100W	160L	4000K/70CRI	120-277V	Type IV Wide	Square Arm	Bronze
RAR1-100-4K-4	12,000	100W	160L	4000K/70CRI	120-277V	Type IV Wide	Square Arm	Bronze
RAR1-135-4K-3	18,000	135W	160L	4000K/70CRI	120-277V	Type IV Wide	Square Arm	Bronze
RAR1-135-4K-4	18,000	135W	160L	4000K/70CRI	120-277V	Type IV Wide	Square Arm	Bronze
RAR2-165-4K-3	21,000	165W	320L	4000K/70CRI	120-277V	Type IV Wide	Square Arm	Bronze
RAR2-165-4K-4	21,000	165W	320L	4000K/70CRI	120-277V	Type IV Wide	Square Arm	Bronze

ORDERING INFORMATION ORDERING EXAMPLE: RFL2-80L-3K7-FR-UNV-ASQ-BL-NXWE-BC
Ordering logic

SERIES	# LEDS	WATTAGE	CCT/CRI	DISTRIBUTION	OPTICS ROTATION	VOLTAGE	MOUNTING SQUARE POLES
RAR1 Ratio Area Size 1	80L-25	25W - 3,000 Lumens	3K7 3000K, 70 CRI	2 TYPE II	Blank for no rotation	UNV Universal 120-277V	ASQ Arm mount for square pole/flat surface
	80L-50	50W - 6,000 Lumens	4K7 4000K, 70 CRI	3 TYPE III		347 347V	ASQU Universal Arm mount for square pole/flat surface
	160L-70	70W - 9,000 Lumens	5K7 5000K, 70 CRI	4W TYPE IV	L Optic rotation left	480 480V	
	160L-100	100W - 12,000 Lumens		5QW TYPE V	R Optic rotation right		
	160L-115	115W - 15,000 Lumens					
RAR2 Ratio Area Size 2	320L-110	110W - 15,000 Lumens					
	320L-140	140W - 18,000 Lumens					
	320L-165	165W - 21,000 Lumens					
	480L-185	185W - 24,000 Lumens					
	480L-210	210W - 27,000 Lumens					
	480L-240	240W - 30,000 Lumens					
	480L-255	255W - 36,000 Lumens					
	480L-295	295W - 42,000 Lumens					
	480L-340	340W - 48,000 Lumens					

Ordering logic (CONT'D)

COLOR	CONTROL OPTIONS NETWORK	OPTIONS
BL Black	NXWE NX Wireless Enabled (module + radio)	BC Backlight control
DB Dark Bronze	NXSPW_F ² NX Wireless, PIR Occ. Sensor, Daylight Harvesting	CD Continuous dimming
GT Graphite	NXSP_F ² NX, PIR Occ. Sensor, Daylight Harvesting	F Fusing (must specify voltage)
GYS Gray Smooth		TB Terminal Block
PS Platinum Silver		2PF ³ 2 power feed with 2 drivers
WH White		
CC Custom Color		
	CONTROL OPTIONS OTHER	
	SCP-40F ⁴ Programmable occupancy sensor	
	7PR 7-Pin twist lock receptacle	
	7PR-SC 7-Pin receptacle with shorting cap	
	7PR-MD40F Low voltage sensor for 7PR	
	7PR-TL 7-Pin PCR with photocontrol	

DIMENSIONS

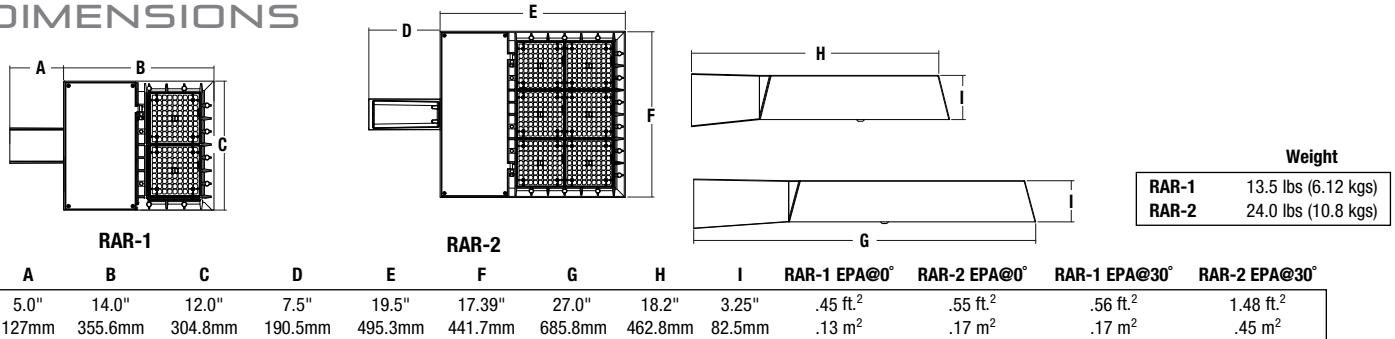

STOCK ACCESSORIES/REPLACEMENT PARTS - Order Separately

Catalog Number	Description
<input type="checkbox"/> RARRPA3DB	Round pole adapter 3.5" TO 4.13"
<input type="checkbox"/> RARA3UDB	Universal mount for square pole or round pole 3.5" to 4.13"

ACCESSORIES/REPLACEMENT PARTS - Order Separately

Catalog Number	Description
<input type="checkbox"/> RAR-ASQU-XX	Universal arm mount for square pole/flat surface
<input type="checkbox"/> RAR-A_U-XX	Universal arm mount for round poles
<input type="checkbox"/> RAR-RPA_XX	Round pole adapter
<input type="checkbox"/> TPLBARA3	Twin parallel luminaire bracket
<input type="checkbox"/> SETAVP	4" square pole top tenon adapter, 2 3/8" OD slipfitter
<input type="checkbox"/> RETAVP	4" round pole top tenon adapter; 2 3/8" OD slipfitter for max. Four fixtures (90°); order 4" round pole adapters separately
<input type="checkbox"/> TETAVP	Three-sided pole top tenon adapter, 2 3/8" OD slipfitter
<input type="checkbox"/> SPIKE	Bird Deterrent
<input type="checkbox"/> RARWB-XX	Wall Bracket - use with Mast Arm Fitter

¹ Replace "_" with "3" for 3.5"-4.13" OD pole, "4" for 4.18"-5.25" OD pole, "5" for 5.5"-6.5" OD pole

CONTROLS ACCESSORIES - Order Separately

Catalog Number	Description
<input type="checkbox"/> SW7PR	SiteSync™ on fixture module via 7PR
<input type="checkbox"/> SWUSB	SiteSync™ Software on USB
<input type="checkbox"/> SWTAB	SiteSync™ Windows Tablet
<input type="checkbox"/> SWBRG	SiteSync™ Wireless Bridge Node
<input type="checkbox"/> SWFC	SiteSync™ Field Commission Service
<input type="checkbox"/> SCPREMOTE	Order at least one per project location to program and control wiSCAPE™ external control node; use with 7PR
<input type="checkbox"/> WIR-RME-L	
<input type="checkbox"/> NXOFM-1R1D-UNV	NX external control node; use with 7PR

MOUNTING

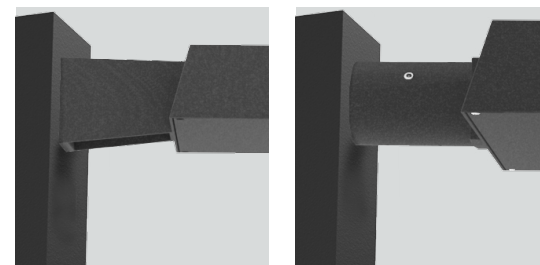

Arm Mount – Fixture ships with integral arm for ease of installation. Compatible with Hubbell Outdoor B3 drill pattern.

MAF – Fits 2-3/8" OD arms Roadway applications.

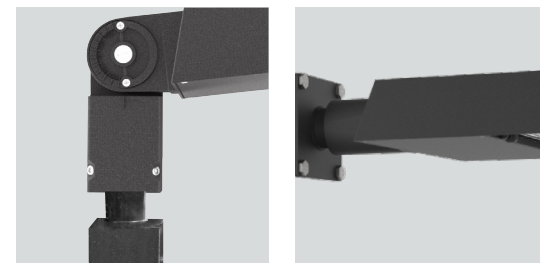

Knuckle – Knuckle mount 15° aiming angle increments for precise aiming and control, fits 2-3/8" tenons or pipes.

Wall Mount – Wall mount bracket designed for building mount applications.

UNIVERSAL MOUNTING BLOCK

Universal mounting block for ease of installation. Compatible with drill patterns from 2.5" to 4.5"

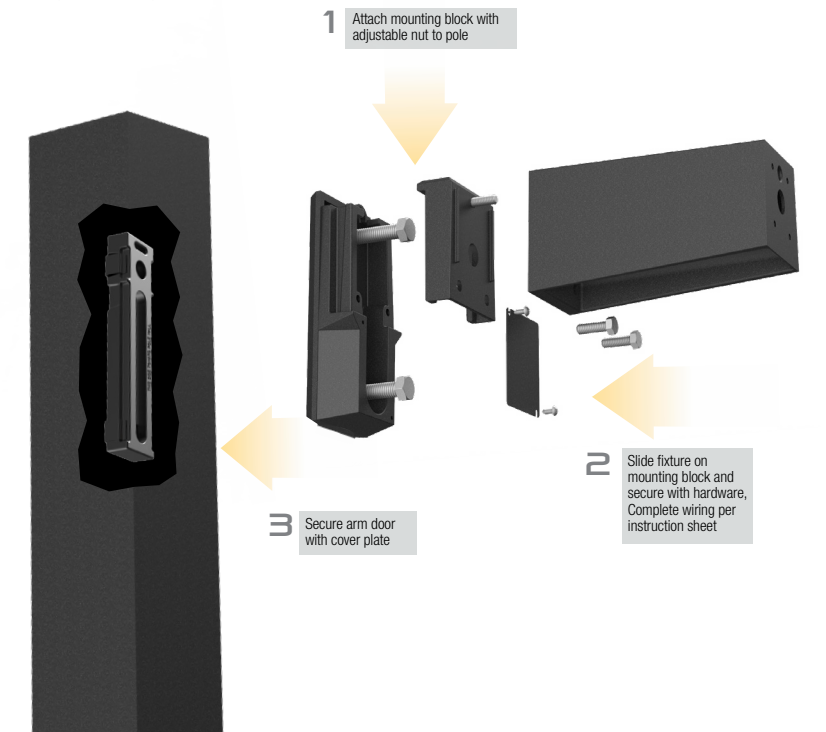

FINISH OPTIONS

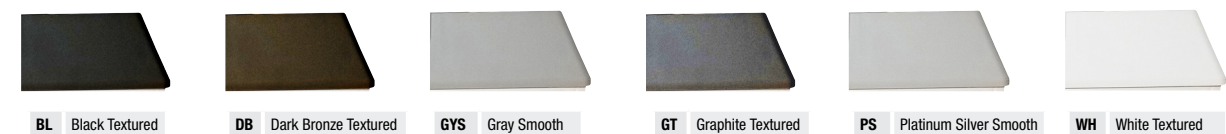

RATIO AREA/SITE ORDERING INFORMATION

ORDERING INFORMATION ORDERING EXAMPLE: RAR3-720L-375-3K7-4W-ASQ-UNV-BLT-SWP-F

Series	# LEDs - Wattage	CCT/CRI	Distribution	Mounting
RAR3 Ratio Area Size 3	720L-375 55,000 Lumens	3K7 3000K, 70 CRI	2 IES TYPE II	ASQ Arm mount for square pole/flat surface
	720L-415 60,000 Lumens	4K7 4000K, 70 CRI	3 IES TYPE III	A3 Arm mount for 3" round pole
	720L-455 65,000 Lumens	5K7 5000K, 70 CRI	4W IES TYPE IV	A4 Arm mount for 4" round pole
	720L-495 70,000 Lumens	3K8 3000K, 80 CRI	5QW IES TYPE V	A5 Arm mount for 5" round pole
	720L-535 75,000 Lumens	4K8 4000K, 80 CRI	N Narrow, 2x2	MAF Mast arm fitter for 2-3/8" OD
	720L-575 80,000 Lumens	5K8 5000K, 80 CRI	M Medium Flood, 4x4	WB Wall bracket
	540L-235 35,000 Lumens		W Wide Flood, 6x6	K Knuckle
	540L-270 40,000 Lumens			K Knuckle
	540L-315 45,000 Lumens			Y Yoke
	540L-355 50,000 Lumens			T Trunnion
	540L-390 55,000 Lumens			
	540L-435 60,000 Lumens			
	540L-480 65,000 Lumens			

Optic Rotation	Voltage	Color	Control Options Network	Options
Blank for no rotation	UNV 120-277V	BLT Black Matte Textured	SWP SiteSync pre-commissioned ³	BC Backlight control
L Optic rotation left	120 120V	BLS Black Gloss Smooth	SWPM_ SiteSync pre-commissioned w/ motion detection ^{3,6}	F Fusing (must specify voltage)
R Optic rotation right	208 208V	DBT Dark Bronze Matte Textured	NXWE NX Wireless Enabled (module + radio)	TB Terminal block
	240 240V	DBS Dark Brone Gloss Smooth	NXSPW_F NX Wireless, PIR Occ. Sensor, Daylight Harvesting ^{2,3,5}	
	277 277V	GTT Graphite Matte Textured	NXSP_F NX, PIR Occ. Sensor, Daylight Harvesting ^{2,3,5}	
	347 347V	LGS Light Grey Gloss Smooth	WIR Wireless Controls, wiSCAPE	
	480 480V	LGT Light Grey Matte Textured	Stand Alone Sensors	
		PSS Platinum Silver Smooth	SCP_F Remote control programmable line voltage sensor (Wattstopper FSP-211B, 221B; all voltages) ^{3,6}	
		WHT White Matte Textured	WSPD_ Bluetooth WASP ^{3,6}	
		WHS White Gloss Smooth	Control Options	
		VGT Verde Green Textured	7PR 7-Pin Receptacle ³	
		Color Option	7PR-SC 7-Pin receptacle with shorting cap ³	
		CC Custom Color	7PR-MD40F Low voltage sensor and 7-Pin Receptacle ³	
			7PR-TL 7-Pin PCR with photocontrol	
			PC Button Photocontrol ⁴	
			ADD AutoDim timer based dimming	
			ADT AutoDim time of day dimming	

- Notes:
- 1 Works with external networked photosensor
 - 2 wiSCAPE Gateway required for system programming
 - 3 Control option not available with yoke or trunnion mounting
 - 4 Not available with 480V
 - 5 Replace "_" with "14" for up to 14' mounting height, "40" for up to 40' mounting height

DIMENSIONS

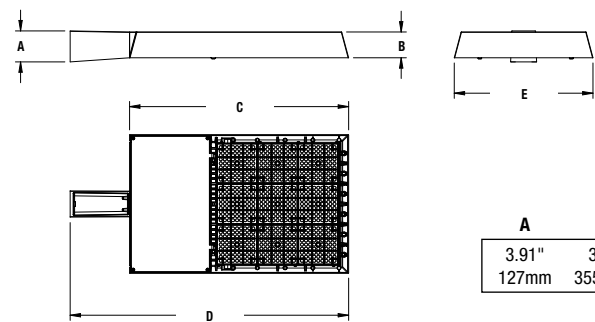

Weight	
RAR-3	35.0 lbs (15.88 kgs)

A	B	C	D	E	RAR3 EPA@0°	RAR3 EPA@30°	RAR3 EPA@60°
3.91"	3.25"	27.62"	35.12"	17.5"	1.1 ft. ²	2.6 ft. ²	4.1 ft. ²
127mm	355.6mm	304.8mm	190.5mm	495.3mm	.10 m ²	.24 m ²	.38 m ²

FINISH OPTIONS

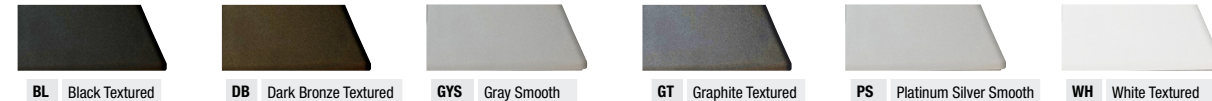

STOCK ACCESSORIES/REPLACEMENT PARTS - Order Separately

Catalog Number	Description
<input type="checkbox"/> RARRPA3DB	Round pole adapter 3.5" TO 4.13"

ACCESSORIES/REPLACEMENT PARTS - Order Separately

Catalog Number	Description
<input type="checkbox"/> RAR-RPA_XX	Round pole adapter
<input type="checkbox"/> TPLBARA3	Twin parallel luminaire bracket
<input type="checkbox"/> SETAVP	4" square pole top tenon adapter, 2 3/8" OD slipfitter
<input type="checkbox"/> RETAVP	4" round pole top tenon adapter; 2 3/8" OD slipfitter for max. Four fixtures (90°); order 4" round pole adapters separately
<input type="checkbox"/> SPIKE	Bird Deterrent
<input type="checkbox"/> RARWB-XX	Wall Bracket - use with Mast Arm Fitter

¹ Replace "_" with "3" for 3.5"-4.13" OD pole, "4" for 4.18"-5.25" OD pole, "5" for 5.5"-6.5" OD pole

House Side Shield Accessories

<input type="checkbox"/> RAR3 HSS-90-B-XXX	House Side Shield Back 90°
<input type="checkbox"/> RAR3 HSS-90-F-XXX	House Side Shield Front 90 deg
<input type="checkbox"/> RAR3 HSS-90-S-XXX	House Side Shield Side 90 deg
<input type="checkbox"/> RAR3 HSS-270-BSS-XXX	House Side Shield Back, Side & Side 270 deg
<input type="checkbox"/> RAR3 HSS-270-FSS-XXX	House Side Shield Front, Side & Side 270 deg
<input type="checkbox"/> RAR3 HSS-270-FSB-XXX	House Side Shield Front, Side & Back 270 deg
<input type="checkbox"/> RAR3 HSS-360-XXX	House Side Shield 360 deg

Replace XXX with notation for desired finish color. Refer to page 8 for shield images.

CONTROLS ACCESSORIES - Order Separately

Catalog Number	Description
<input type="checkbox"/> SW7PR	SiteSync™ on fixture module via 7PR
<input type="checkbox"/> SWUSB	SiteSync™ Software on USB
<input type="checkbox"/> SWTAB	SiteSync™ Windows Tablet
<input type="checkbox"/> SWBRG	SiteSync™ Wireless Bridge Node
<input type="checkbox"/> SWFC	SiteSync™ Field Commission Service
<input type="checkbox"/> SCPREMOTE	Order at least one per project location to program and control
<input type="checkbox"/> WIR-RME-L	wiSCAPE™ external control node; use with 7PR
<input type="checkbox"/> NXOFM-1R1D-UNV	NX external control node; use with 7PR

MOUNTING



Arm Mount – Fixture ships with integral arm for ease of installation. Compatible with Hubbell Outdoor B3 drill pattern. Available on Area configurations.

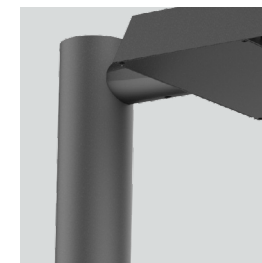

MAF – Fits 2-3/8" OD arms Roadway applications. Available on Area configurations.

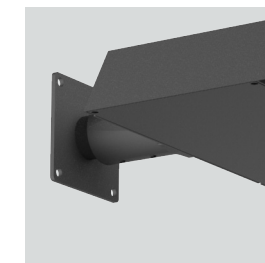

Wall Mount – Wall mount bracket designed for building mount applications. Available on Area configurations.



Knuckle – Knuckle mount 15° aiming angle increments for precise aiming and control, fits 2-3/8" tenons or pipes. Available on Area and Flood configurations.

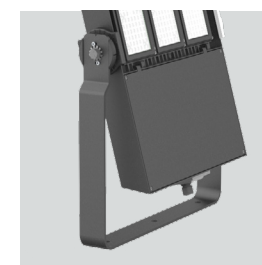

Yoke – For mounting directly to flat surfaces or crossarms. Available on flood configurations.



Trunnion – For mounting directly to flat surfaces or crossarms. Available on flood configurations.

RATIO FLOOD ORDERING INFORMATION

STOCK ORDERING INFORMATION

CATALOG DESCRIPTION	MOUNTING	DISTRIBUTION	WATTAGE	VOLTAGE	CCT	LUMENS	LPW	WEIGHT LBS. (KG)	FINISH
RFL2-25-4K	Knuckle	Wide	26	120-277V	4000K	3267	126	3.7 (1.68)	Bronze
RFL2-25-5K	Knuckle	Wide	26	120-277V	5000K	3283	126	3.7 (1.68)	Bronze
RFL3-40-4K	Knuckle	Wide	34	120-277V	4000K	4804	141	5.5 (2.5)	Bronze
RFL3-40-5K	Knuckle	Wide	34	120-277V	5000K	4827	142	5.5 (2.5)	Bronze
RFL3-50-4K*	Knuckle	Wide	50	120-277V	4000K	6823	132	5.5 (2.5)	Bronze
RFL3-50-5K*	Knuckle	Wide	50	120-277V	5000K	6655	129	5.5 (2.5)	Bronze

*Also available with photocontrol

ORDERING INFORMATION ORDERING EXAMPLE: RFL2-44-25-4K7-M-UNV-K-DB

Ordering logic

SERIES	# LEDS	WATTS	CCT/CRI	DISTRIBUTION	VOLTAGE	MOUNTING	COLOR	CONTROL OPTIONS
RFL2 Ratio Flood Size 2	44 44 LEDs	25 3,000 lm	3K7 3000K, 70 CRI	N Narrow, 2x2 M Medium Flood, 4x4 W Wide Flood, 6x6	UNV Universal 120-277	K Knuckle	BL Black DB Dark Bronze GT Graphite GYS Gray Smooth PS Platinum Silver WH White	CD Continuous Dimmable PC Button Photocontrol
RFL3 Ratio Flood Size 3	90 90 LEDs	40 5,000 lm 50 7,000 lm	4K7 4000K, 70 CRI 5K7 5000K, 70 CRI					

ACCESSORIES/REPLACEMENT PARTS - Order Separately

Catalog Number	Description
<input type="checkbox"/> S-302	Slipfits 1 1/2" or 2" pipe (1.9" OD or 2 3/8" OD) with 1/2" N.P.S.M. hub; Gray
<input type="checkbox"/> S-302-M51	Slipfits 1 1/2" or 2" pipe (1.9" OD or 2 3/8" OD) with 1/2" N.P.S.M. hub; Bronze
<input type="checkbox"/> S-302-M52	Slipfits 1 1/2" or 2" pipe (1.9" OD or 2 3/8" OD) with 1/2" N.P.S.M. hub; White
<input type="checkbox"/> TRN-XX'	Trunnion adapter for 1/2" threaded knuckle mount

¹Specify finish color to match fixture, e.g. DB - Bronze.

DIMENSIONS

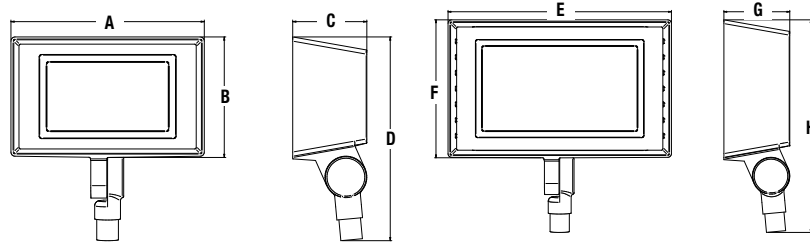

A	B	C	D	E	Weight
7.5"	4.7"	2.9"	7.9"	9.8"	RFL2 3.7 lbs (1.68 kgs)
191mm	119mm	74mm	201mm	249mm	RFL3 5.5 lbs (2.50 kgs)
F	G	H	RFL2 EPA(Front/Side)	RFL3 EPA(Front/Side)	
6.0"	2.9"	9.3"	0.34ft ² / 0.17ft ²	0.97ft ² / 0.20ft ²	
152mm	74mm	236mm			

STOCK ORDERING INFORMATION

CATALOG DESCRIPTION	MOUNTING	DISTRIBUTION	WATTAGE	VOLTAGE	CCT	LUMENS	LPW	WEIGHT LBS. (KG)	FINISH
RFL4-120-5K-K	Knuckle	Wide	124W	120-277V	5000K	14432	116	16.0 (7.26)	Bronze
RFL4-120-4K-K	Knuckle	Wide	124W	120-277V	4000K	14360	116	16.0 (7.26)	Bronze
RFL5-265-5K-K	Knuckle	Wide	266W	120-277V	5000K	30649	115	25.7 (11.66)	Bronze
RFL5-265-4K-K	Knuckle	Wide	266W	120-277V	4000K	30496	115	25.7 (11.66)	Bronze
TRN-RFL - Trunnion Kit									

**Also available with Trunnion

ORDERING INFORMATION ORDERING EXAMPLE: RFL4-176-95-4KL-M-UNV-K-GYS

Ordering logic

SERIES	# LEDS	WATTS	CCT/CRI	DISTRIBUTION	VOLTAGE	MOUNTING	COLOR
RFL4 Ratio Flood Size 4	176 176 LEDs	95 12,000 lm 120 15,000 lm	3K7 3000K, 70 CRI 4K7 4000K, 70 CRI	N Narrow, 2x2 M Medium Flood, 4x4 W Wide Flood, 6x6	UNV Universal 120-277	K Knuckle T Trunnion	BL Black DB Dark Bronze GT Graphite GYS Gray Smooth PS Platinum Silver WH White
RFL5 Ratio Flood Size 5	360 360 LEDs	130 18,000 lm 190 25,000 lm 265 30,000 lm	5K7 5000K, 70 CRI				

Ordering logic (CONT'D)

CONTROL OPTIONS

NXWE	NX Wireless Enabled (module + radio)
NXSPW_F¹	NX Wireless, PIR Occ. Sensor, Daylight Harvesting
NXSP_F²	NX, PIR Occ. Sensor, Daylight Harvesting

OPTIONS

SP	Surge Protector
F	Fusing
PCL	Polycarbonate Lens

CONTROL OPTIONS OTHER

SCP_F²	Programmable occupancy sensor
7PR	7-Pin twist lock receptacle
7PR-SC	7-Pin receptacle with shorting cap
7PR-MD_F²	Low voltage sensor for 7PR
7PR-TL	7-Pin PCR with photocontrol

¹ Replace "F" with "14" for up to 14' mounting height, "30F" for 15-30' mounting height
² Replace "F" with "8" for up to 8' mounting height, "40F" for 9-40' mounting height

See specification sheet for complete ordering information.

ACCESSORIES/REPLACEMENT PARTS - Order Separately

Catalog Number	Description
<input type="checkbox"/> RFL4-TV	Top Visor - RFL4
<input type="checkbox"/> RFL4-FL	Louver - RFL4
<input type="checkbox"/> RFL5-TV	Top Visor - RFL5
<input type="checkbox"/> RFL5-FL	Louver - RFL5

See www.HubbellLighting.com for mounting bracket information.

DIMENSIONS

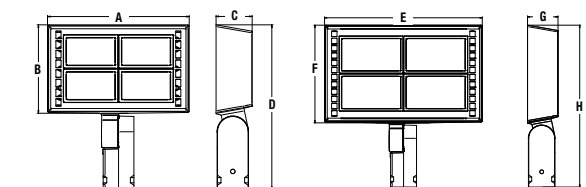

A	B	C	D	E	Weight
13.8"	8.6"	3.5"	16.0"	18.1"	RFL4 16 lbs (7.26 kgs)
351mm	218mm	89mm	406mm	460mm	RFL5 25.7 lbs (11.66 kgs)
F	G	H	RFL4 EPA(Front/Side)	RFL5 EPA(Front/Side)	
11.2"	3.5"	18.6"	1.24ft ² / 0.43ft ²	2.00ft ² / 0.50ft ²	
152mm	89mm	472mm			



ARCHITECTURAL AREA LIGHTING

BEACON PRODUCTS

COLUMBIA LIGHTING

COMPASS

DUAL-LITE

HUBBELL CONTROL SOLUTIONS

HUBBELL OUTDOOR LIGHTING

KIM LIGHTING

KURT VERSEN

LITECONTROL

PRESCOLITE



701 Millennium Blvd. Greenville, SC 29607
Tel 864.678.1000
www.hubbelloutdoor.com

HOL00339 2.5K November 17, 2020 2:10 PM

Copyright © 2020 Hubbell Outdoor Lighting, a division of Hubbell Lighting, Inc. All rights reserved.
Please refer to online specifications for most up-to-date content as specifications are subject to change without notice.
Due to our continued efforts to improve our products, product specifications are subject to change without notice.